

Cracking the code



Vision Lab @ IISc



BioSystems Science and Engineering

Dissimilarity learning via Siamese network predicts brain imaging data

Aakash Agrawal

Why Algonauts?

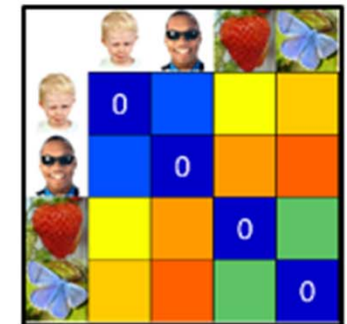
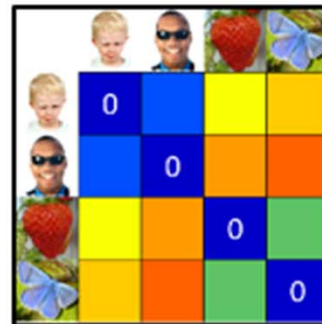
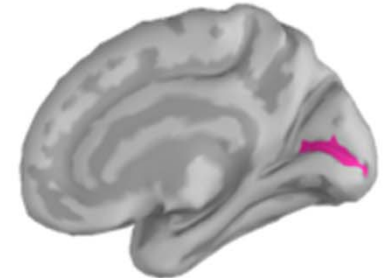
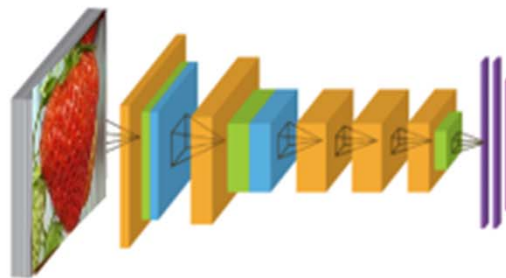

N	N	N	N
N	N	W	N
N	N	N	N
N	N	N	N
N	T	N	N
N	N	N	N
N	N	N	N

Letter representation in the brain

Visual Search

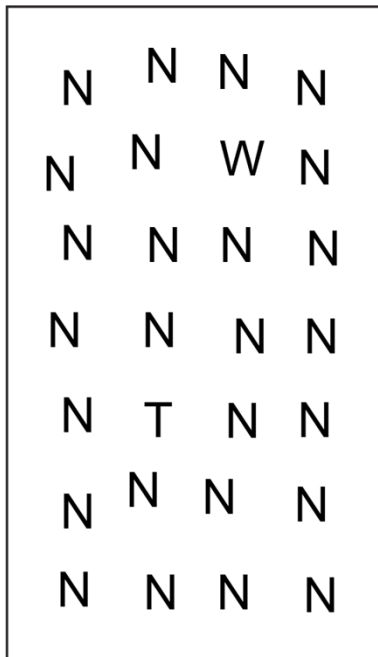

Dissimilarity = 1/response time

Visual search space

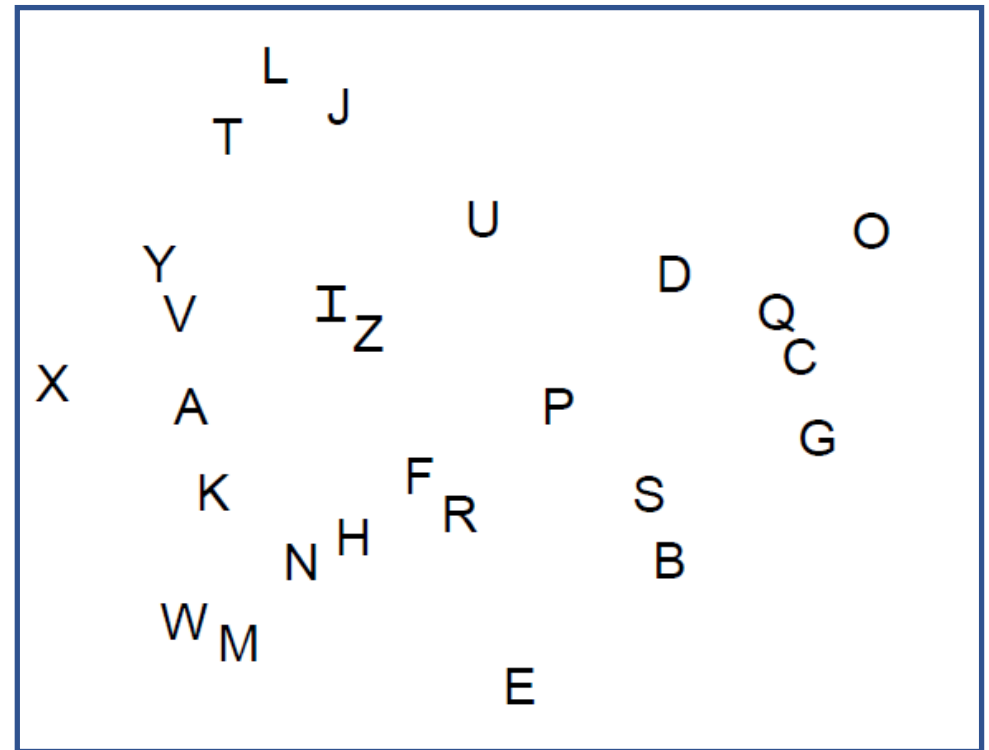



bioRxiv
THE PREPRINT SERVER FOR BIOLOGY

Behaviour



New Results

A compositional shape code explains how we read jumbled words

Aakash Agrawal, K.V.S. Hari, S. P. Arun



bioRxiv
THE PREPRINT SERVER FOR BIOLOGY

HC



Behaviour + fMRI



New Results

Comment on

Reading Increases the Compositionality of Visual Word Representations

Aakash Agrawal, K.V.S. Hari, S. P. Arun

Behaviour

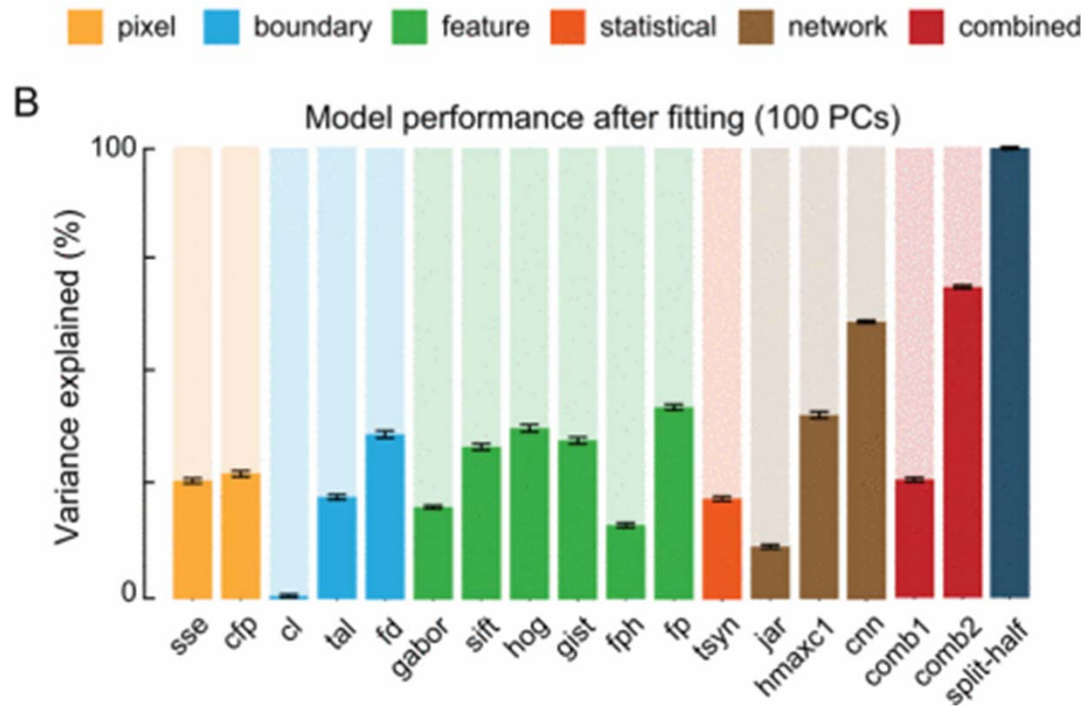

Pramod & Arun, 2016

fMRI

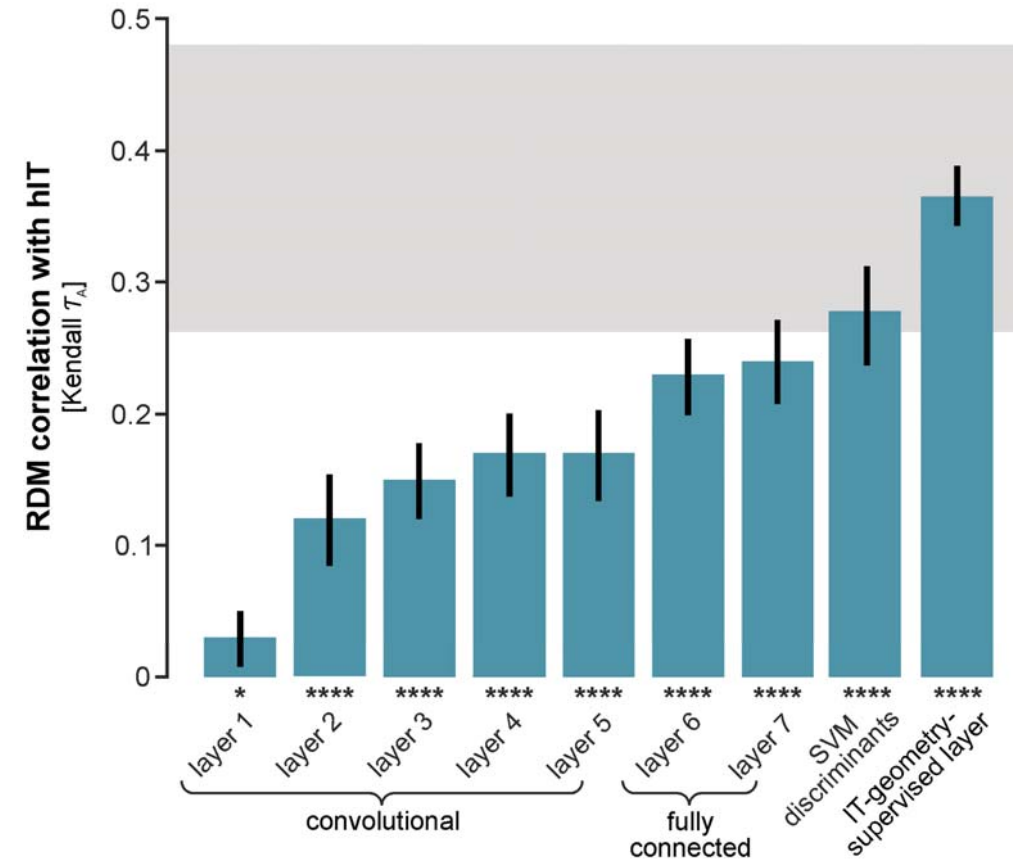

Khaligh-Razavi & Kriegeskorte, 2014

Siamese networks

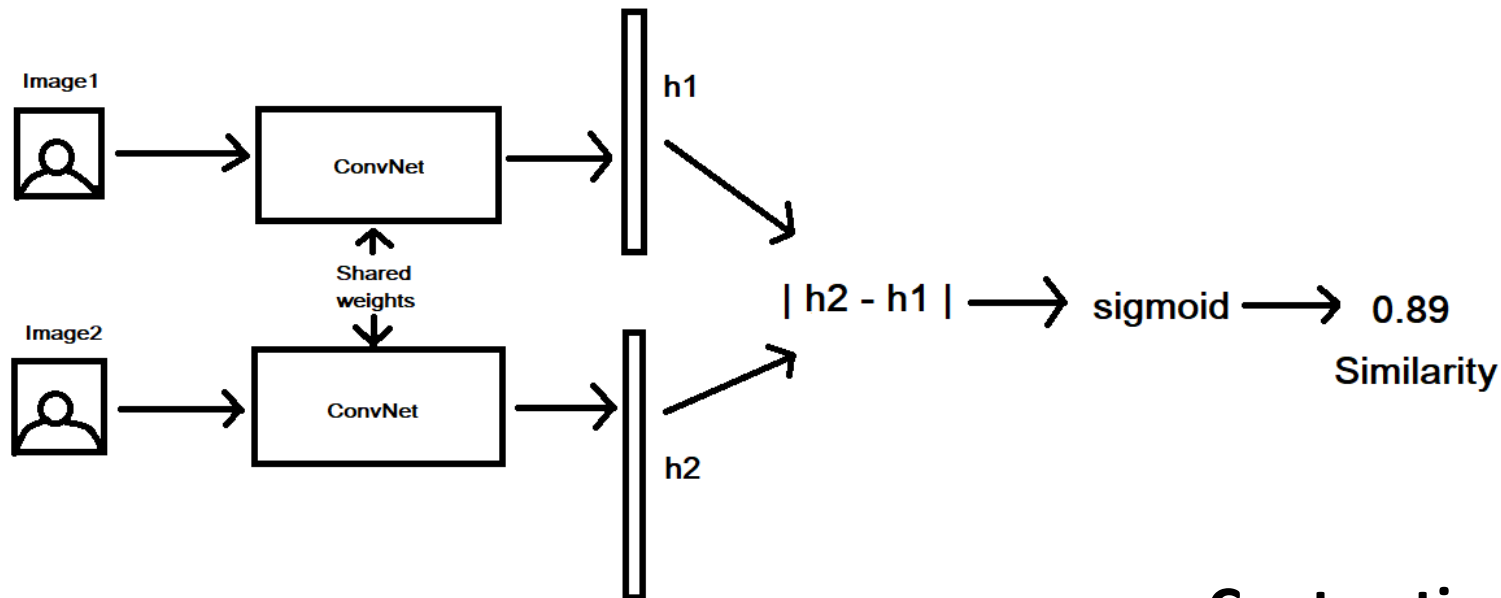

Contrastive Loss

$$L = -(y)\log(p) + (1-y)\log(1-p)$$

where L is the loss function,
 y the class label (0 or 1) and p is the prediction.

Modified siamese networks

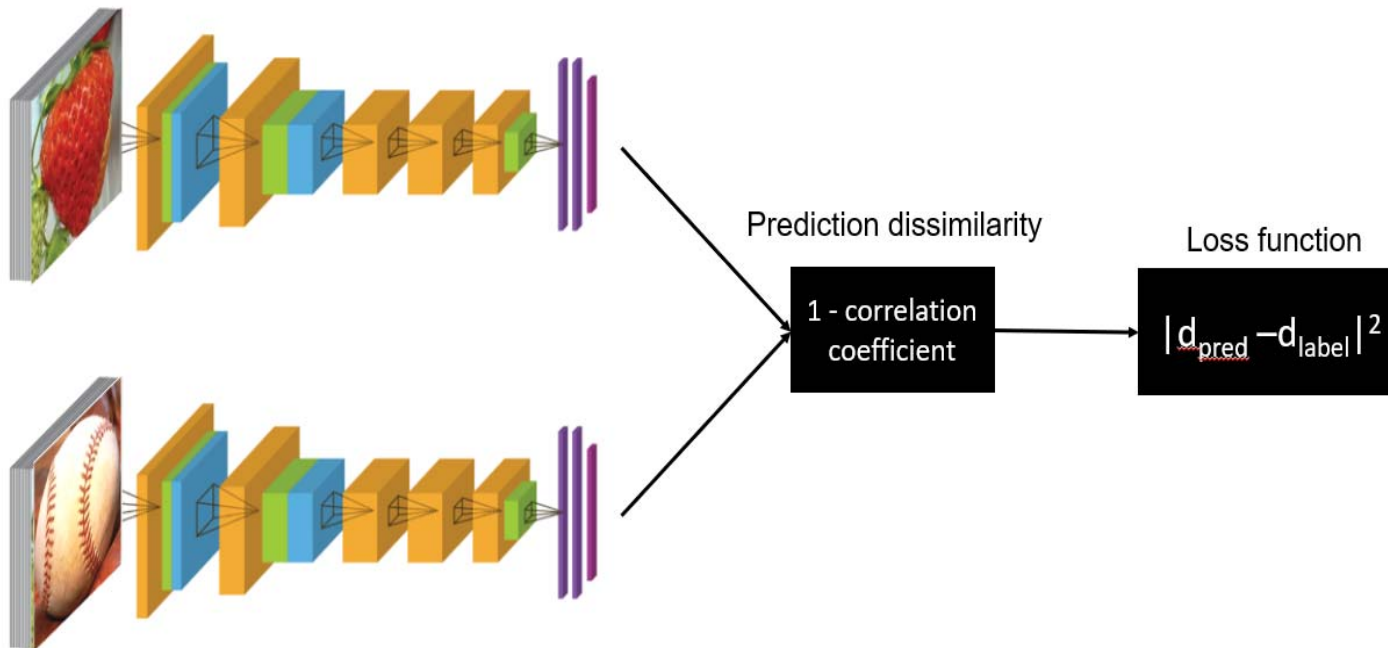

Exploration list

- 1) Architecture
- 2) Layers to fine-tune
- 3) Feature extraction layer
- 4) Epoch
- 5) Loss function
- 6) Training dataset
- 7) Other hyperparameter – learning rate, batch size, etc.

EVC/ MEG early – AlexNet
IT/ MEG late – VGG16

Pre-processing

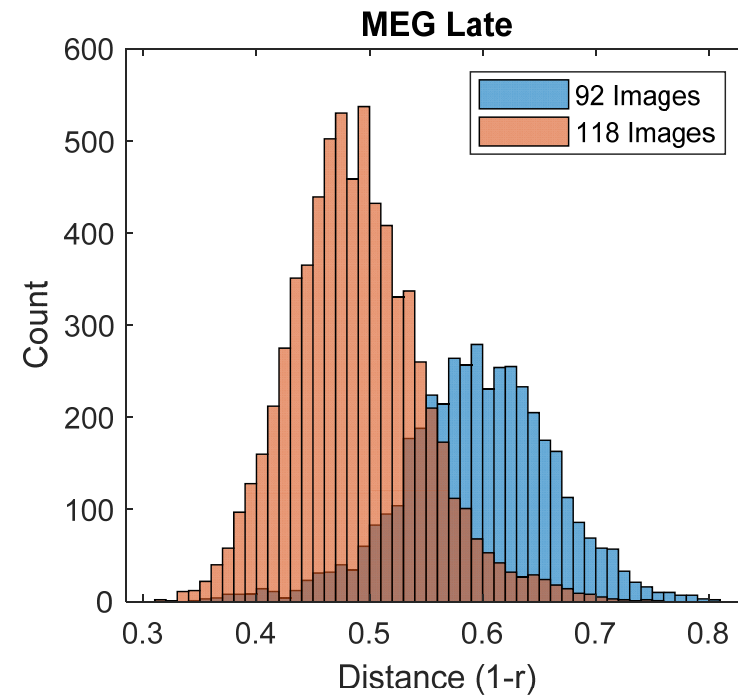
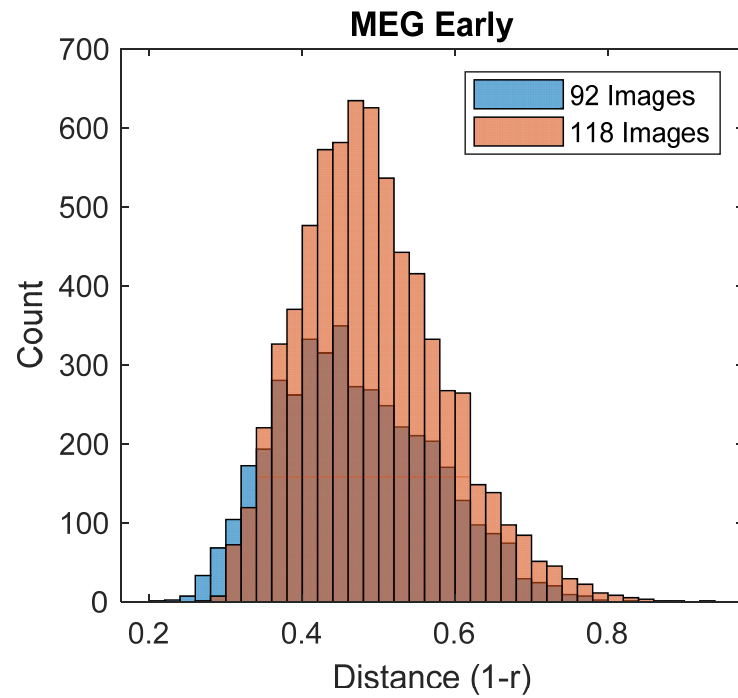

MEG RDMs early

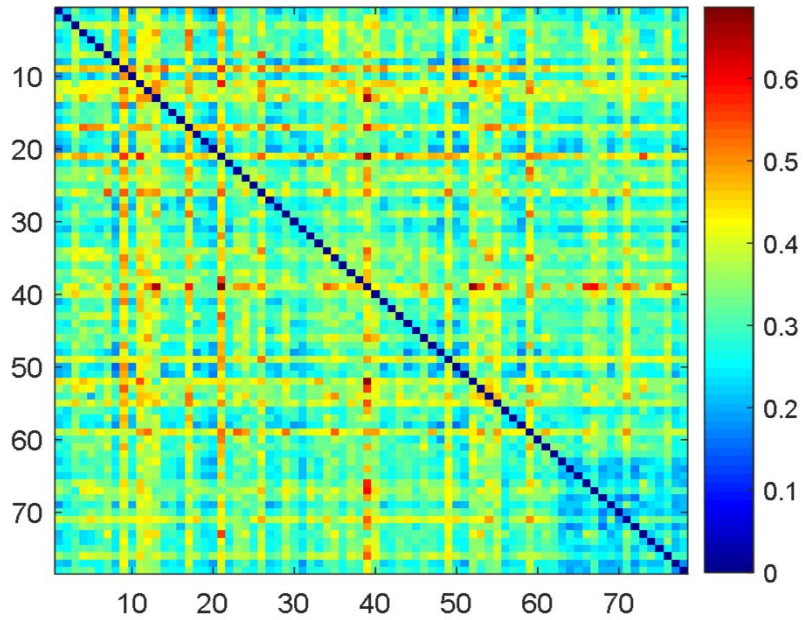

MEG RDMs late

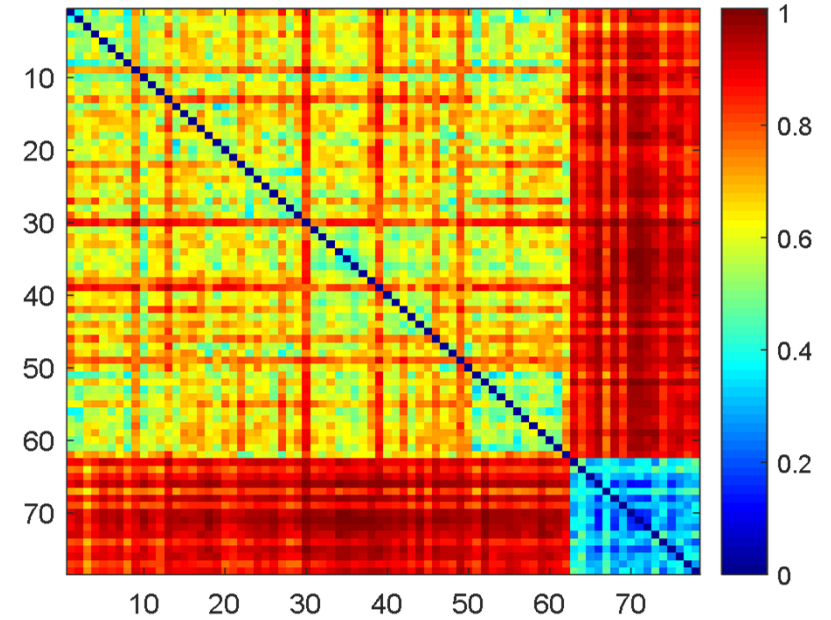

layer 12 from epoch 164
(MEG_early_RDMs)

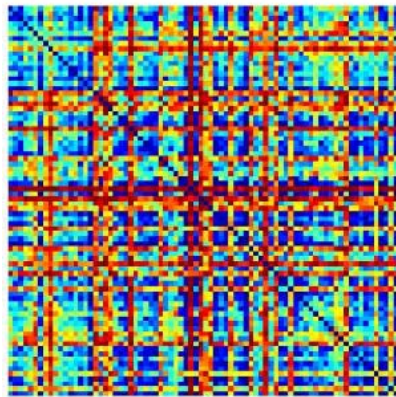

layer 34 from epoch 13 of
(MEG_late_RDMs)

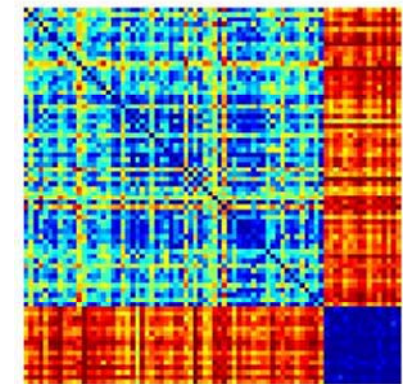

MEG test RDMs

Which layers were affected by fine-tuning?

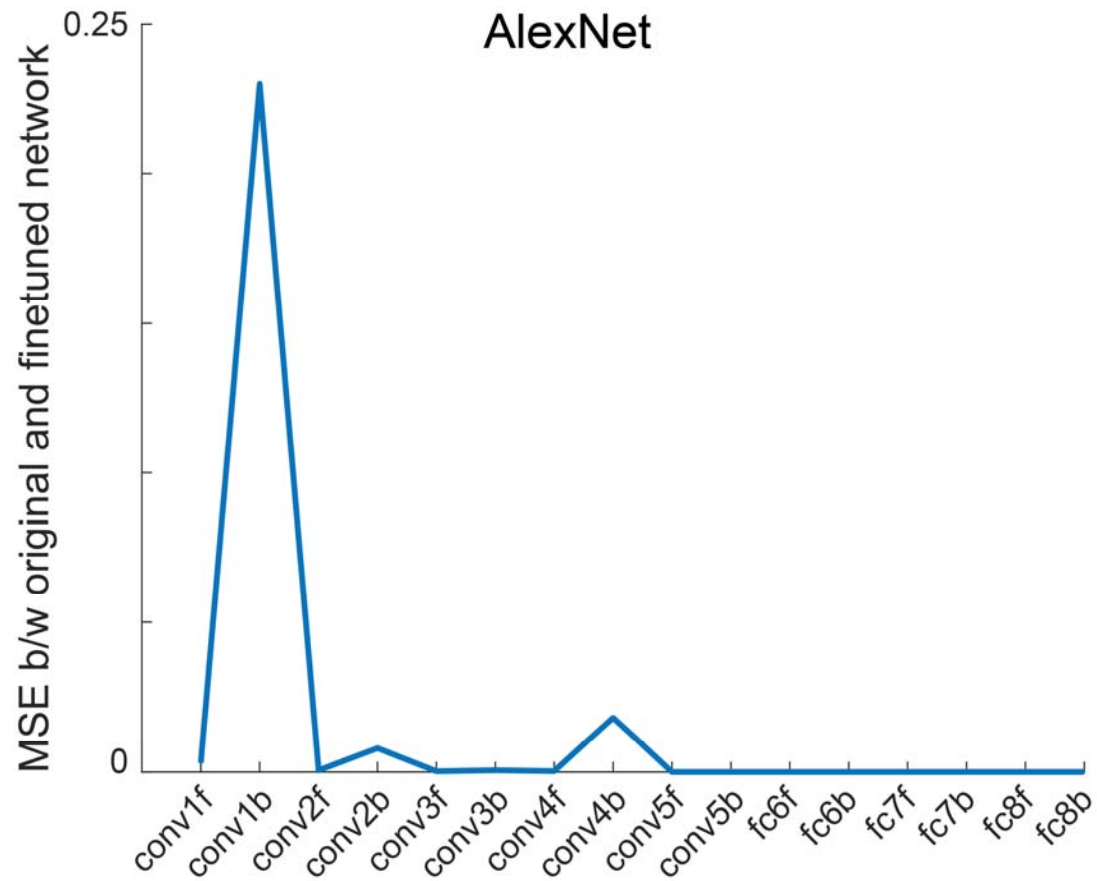

Which layers were affected by fine-tuning?

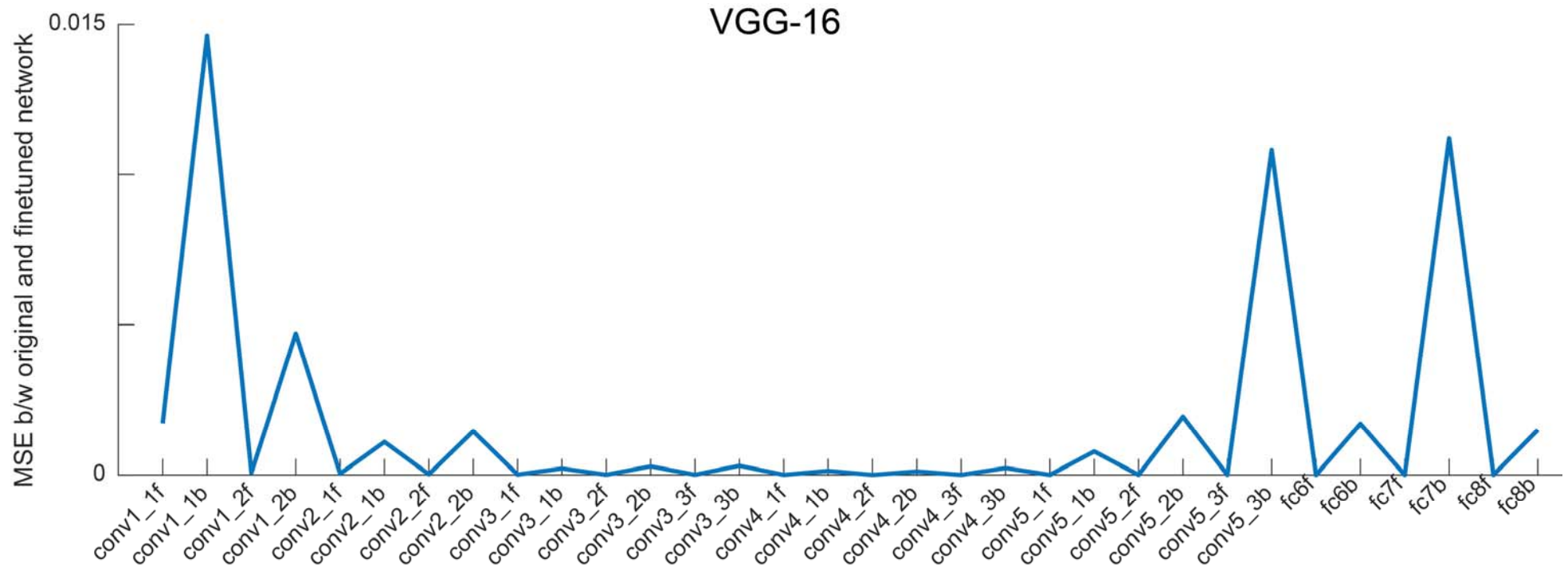

Summary

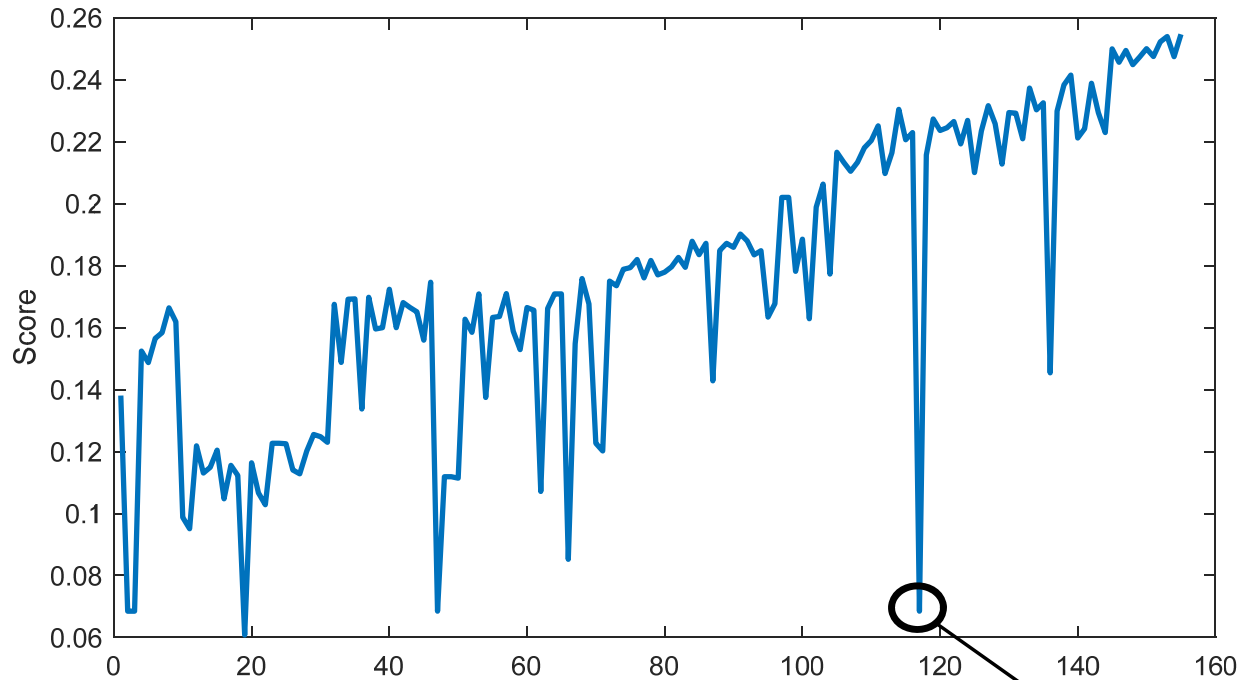

Trained from scratch

Exploration list

- 1) Architecture
- 2) Layers to fine-tune
- 3) Feature extraction layer
- 4) Epoch
- 5) Loss function
- 6) Training dataset
- 7) Other hyperparameter – learning rate, batch size, etc.